



Dave White's

SitePro™

OPERATING MANUAL



models
DL24, DL48

DIGITAL
LEVELS



IMPORTANT:
Read Before Using

IMPORTANT:
Lire avant usage

IMPORTANTE:
Leer antes de usar

GENERAL SAFETY RULES

The intended use of the DL24 and DL48 digital level is for quick and precise measurement of inclinations and angles.

Working safely with this instrument is possible only when the operating and safety information are read completely and the instructions contained therein are strictly followed. The use of controls, adjustments, or the performance of procedures other than those specified herein may result in hazardous radiation exposure.

DO NOT disassemble the instrument or attempt to perform any internal servicing. Repair and servicing of this level are to be performed only by SitePro or authorized service centers.

- When attaching the instrument to a tripod, make sure the instrument is securely fixed. The tripod leg clamps should be securely fastened. If not securely fastened or tightened, the main unit could fall off or the tripod could fall over.
- Store inside the carry case and place in a dry area not subject to vibration, dust or high moisture. If the storage temperature and ambient temperature for usage vary significantly, leave the level in its case until it can adjust to the ambient temperature.

TECHNICAL DATA







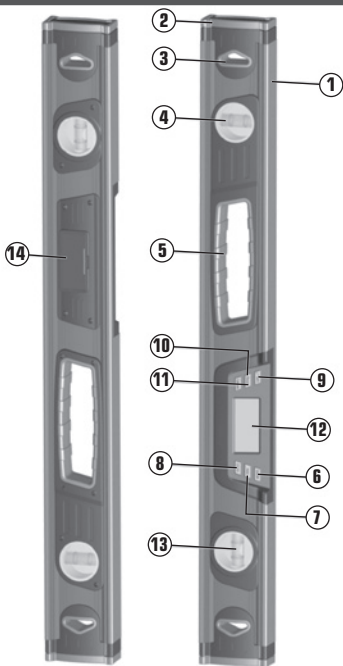



Item	29-DL24	29-DL48
Length	24" (610mm)	48" (1219mm)
Measuring Range	0–360° (4 x 90°)	
Measuring Accuracy	0° and 90° – 1° to 89°	±0.1° ±0.2°
Power Supply	2 x AAA Alkaline Batteries	
Operating Temperature	32° F ... 104° F (0°C ... +40 °C)	
Weight	1.34 lb (610g)	2.65 lb (1200g)
Dimensions	23.7" x 2.6" x 1.2" (62 x 6.6 x 3 cm)	47.3" x 2.6" x 1.2" (120 x 6.6 x 3 cm)

Specifications subject to change without notice.

FEATURES

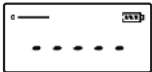

Item	Description
1	Aluminum Level Edge
2	Soft Rubber Protective Cap
3	Hanging Hole for Storage
4	Vertical Spirit Level
5	Ergonomic Rubber Handel
6	Power "ON/OFF" Button
7	HOLD Button
8	LED Light/Sound Button
9	Unit of Measure "°, %, in/ft" Button
10	Reset Button
11	Calibrate Button
12	LCD Display
13	Horizontal Spirit Level
14	Battery Compartment

Press	Duration	
	> 2 sec.	
	< 2 sec.	
	< 2 sec.	
	\geq 2 sec.	
	< 2 sec.	Press Once: IN/FT = Slope display is 0 to 12" (ref. 0 to 45°)
	< 2 sec.	
	< 2 sec.	Press Once: Set temperature to display in °F. (Default)

Tilt indicator



The upper left corner of the display shall show a general indicator of direction/magnitude of tilt of the product.

At level or 0.0°, only the  will be displayed.

From 0.1° to 14.9° of counter clockwise tilt, the display is show 

Every 15.0°, another block will be added to the tilt indicator until all blocks are shown.



	Function
	Turns Power ON and OFF
	Holds the currently displayed angle even if the levels position changes. Releases the angle display to show the current angle.
	Turns ON and OFF the speaker. The speaker will sound when the display shows 0, 45 or 90°.
	Turns ON and OFF LCD backlight. (Backlight with turn OFF automatically after 3 minutes of inactivity)
Press Twice: % = Grade display is 0 to 100% (ref. 0 to 45°)	Once: Display changes from "IN/FT" to "%" (Grade). Twice: Display changes from "%" to "°".
	The angle displayed will be reset to a Reference Zero Point. The display shows "- - - -", then "ABS" flashes while in this mode. Press again to return display to original zero point.
Press Twice: Set temperature to display in °C.	Set the temperature display to ° Fahrenheit or ° Celcius

When the product is tilted clockwise, the blocks will appear on the other side of the center line in the same manner as described for the counter clockwise tilting of the product.



OPERATIONS

- **Protect the measuring tool against moisture and direct sun.**
- **Do not expose the measuring tool to extreme temperatures or variations in temperature.**



Power On and Off

- Press the **"ON/OFF"** button to switch the digital level on or off.

Holding a Measured Value

- Press the **HOLD** button. The current measured value on the display is held. An 'H' will appear on display indicating that the measurement is held.
- Press the **HOLD** button again to start a new measurement.

Changing the Unit of Measure

The default unit of measurement is degrees (°). It is possible to change between the " ° ", "inches/feet" and " % " units of measure at any time.

- Press the **"L ° in/ft"** button to alternate between the modes of measurement.

Sound

The acoustic signal can be switched on and off by pressing the **"SOUND/LIGHT"** symbol button on the display.

- Press again to deactivate the sound option.

NOTE: When the Sound has been activated, the Digital Level will beep at every 45° that it moves.

LCD Back Light

- Press and hold the "**SOUND/LIGHT**" button for 2 seconds to activate the LCD Back Light for the display.
- Press and hold the button down again for 2 seconds to deactivate the LCD Back Light Display.

Rotation of the Reading

Depending on the position of the digital level, the measured value and the unit of measure are indicated in the display rotated by 180°. Thus, the indication can also be read for overhead work.





Set Relative Angle Measurement

- Press the **RESET** button.
- The LCD display will show 0.0°, using the present angle as the initial angle. The later observed results will be the relative value.
- Once the level has been turned OFF, it will return to the absolute measurement angle mode.

BATTERY VOLTAGE INDICATOR

The LCD display has four different settings to indicate the voltage of the battery.

NOTE: When the battery has a charge of less than 7V, the unit will beep every ten seconds to indicate that it is time to replace the battery.

Image	Voltage
	> 8V
	< 8V (± 0.2V)
	< 7.5V (± 0.2V)
	< 7V (± 0.2V)

Checking the Measuring Accuracy

Check the accuracy of the digital level each time before using, after extreme temperature changes as well as after heavy jolts or impact.

The accuracy check should take place on a level and roughly horizontal surface. Power ON the digital level and place it on the horizontal surface.

Select the unit of measure “°”. Wait for 10 seconds and note down the measured value.

Rotate the digital level by 180° around the vertical axis. Wait again for 10 seconds and note down the second measured value.

Calibrate the measuring tool only when the difference between both reading values is greater than 0.1°.

CALIBRATION

NOTE: When the ambient temperature changes considerably, a calibration will be in order to maintain the accuracy of measurements.

- Press the “**ON/OFF**” button to turn the unit on.
- The LCD display will show the current angle.
- Press and hold the “**ON/OFF**” button for 2 seconds to enter normal measuring mode.
- In this mode, you need only to calibrate the horizontal surface.

NOTE: The \angle ° in/ft, **RESET** and **HOLD** buttons will not work in Calibration mode.

- Press the **CALIBRATE** button and hold down for 4 seconds. The LCD screen will display CAL1.

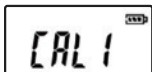

- Put the digital level on a flat surface and press the **CALIBRATE** button again, the number 1 will start to flash. After a few seconds, the display will change to CAL2.



- Flip the Level over 180° (see figure below) and press the **CALIBRATE** button. The number 2 will start to flash after a few seconds. This will indicate that



the calibration has been completed.

- The unit will automatically shutoff if it is stationary for three minutes.

NOTE: An incorrect calibration will occur if there is too much deviation in the horizontal calibration positions, or if the level has been shaken.

MAINTENANCE

Store and transport the digital level only in the supplied protective case. Keep the tool clean at all times. Do not immerse the tool into water or other fluids. Wipe off debris using a moist and soft cloth. Do not use any cleaning agents or solvents.

WARRANTY

Dave White's SitePro ("Seller") warrants to the original purchaser only, that DL-series digital levels will be free from defects in material or workmanship for a period of one (1) year from date of purchase.

SELLER'S SOLE OBLIGATION AND YOUR EXCLUSIVE REMEDY under this Limited Warranty and, to the extent permitted by law, any warranty or condition implied by law, shall be the repair or replacement of parts, without charge, which are defective in material or workmanship and which have not been misused, carelessly handled, or mis-repaired by persons other than Seller or an Authorized Service Center. To make a claim under this Limited Warranty, you must return the complete product, transportation prepaid, to any SitePro Authorized Service Center. Please include a dated proof of purchase with your tool. For locations of nearby service centers, e-mail us at info@sitepro.us.com or call 1-855-354-9881.

THIS LIMITED WARRANTY DOES NOT APPLY TO ACCESSORY ITEMS SUCH AS TRIPODS, RODS, HAND LEVELS, FIELD SUPPLIES, TAPES, MOUNTING DEVICES AND OTHER RELATED ITEMS. THESE ITEMS RECEIVE A 90 DAY LIMITED WARRANTY.

All rotary lasers and optical instruments will be free from defects in material or workmanship for a period of two (2) years from date of purchase.

ANY IMPLIED WARRANTIES SHALL BE LIMITED IN DURATION TO ONE YEAR FROM DATE OF PURCHASE. SOME STATES IN THE U.S., AND SOME CANADIAN PROVINCES DO NOT ALLOW LIMITATIONS ON HOW LONG AN IMPLIED WARRANTY LASTS, SO THE ABOVE LIMITATION MAY NOT APPLY TO YOU.

IN NO EVENT SHALL SELLER BE LIABLE FOR ANY INCIDENTAL OR CONSEQUENTIAL DAMAGES (INCLUDING BUT NOT LIMITED TO LIABILITY FOR LOSS OF PROFITS) ARISING FROM THE SALE OR USE OF THIS PRODUCT. SOME STATES IN THE U.S., AND SOME CANADIAN PROVINCES DO NOT ALLOW THE EXCLUSION OR LIMITATION OF INCIDENTAL OR CONSEQUENTIAL DAMAGES, SO THE ABOVE LIMITATION MAY NOT APPLY TO YOU.

THIS LIMITED WARRANTY GIVES YOU SPECIFIC LEGAL RIGHTS, AND YOU MAY ALSO HAVE OTHER RIGHTS WHICH VARY FROM STATE TO STATE IN THE U.S., OR PROVINCE TO PROVINCE IN CANADA AND FROM COUNTRY TO COUNTRY.

THIS LIMITED WARRANTY APPLIES ONLY TO PRODUCTS SOLD WITHIN THE UNITED STATES OF AMERICA, CANADA AND THE COMMONWEALTH OF PUERTO RICO. FOR WARRANTY COVERAGE WITHIN OTHER COUNTRIES, CONTACT YOUR LOCAL SITEPRO DEALER OR IMPORTER.



Dave White's

SiteProTM

©2017 Dave White's SitePro LLC
Lafayette, IN USA

www.dwsitepro.com

© 2017-2018 copyright Dave White's SitePro LLC. All rights reserved.
SitePro and the Aperture & D W logo are trademarks of Dave White's SitePro LLC,
in the United States and in other countries. All other trademarks are the property of
their respective owners. Design and specification of products are subject to change
without notice.